



Outperform every day.™

Project:
Item Number:
Quantity:

Sous Vide Immersion Circulator

The Vollrath Company, L.L.C.

SOUS VIDE IMMERSION CIRCULATOR



40868



40861

ITEMS

- 40868 Immersion Circulator (head only)
- 40861 Immersion Circulator (head, bath and cover)

FEATURES

- Stainless steel housing for durability
- Temperature stability to 0.1°F (0.06°C) for precise results
- Maximum temperature is 200°F (93°C)
- Two pump speeds for flexible cooking
- Three convenient programmable settings
- LED display is easy to read
- Celsius or Fahrenheit temperature readouts for precise cooking
- 40861 includes a convenient factory fitted drain valve for easy cleaning
- 6 ft. (1.8m) cord and plug

Note: When using Vollrath circulating head 40868 tank capacity must not exceed 7.9 gallons (30L)

DESCRIPTION

The Vollrath Sous Vide Thermal Immersion Circulator is available as a complete cooking unit with a water bath and cover; or as just a Thermal Immersion Circulator head. The Sous Vide Thermal Immersion Circulator complements Vollrath's In-Chamber and Out-of-Chamber Vacuum Pack machines and Cayenne® Charbroilers to provide a complete Sous Vide prep and cooking solution.

Agency Listings

Circulator Head



Water Bath and Cover



WARRANTY

All models shown come with Vollrath's standard warranty against defects in materials and workmanship. For full warranty details, please refer to www.Vollrath.com.

Due to continued product improvement, please consult www.vollrath.com for current product specifications.

Approvals	Date



Outperform every day.™

www.vollrath.com

The Vollrath Company, L.L.C.

1236 North 18th Street
Sheboygan, WI 53081-3201 U.S.A.
Main Tel: 800.624.2051 or 920.457.4851
Main Fax: 800.752.5620 or 920.459.6573
Customer Service: 800.628.0830
Canada Customer Service: 800.695.8560

Technical Services
techservicereps@vollrathco.com
Induction Products: 800.825.6036
Countertop Warming Products: 800.354.1970
All Other Products: 800.628.0832

SOUS VIDE IMMERSION CIRCULATOR

DIMENSIONS (Shown in inches (cm))

40868

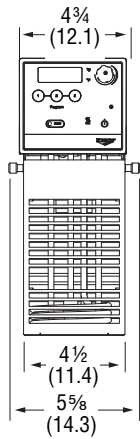

Front View

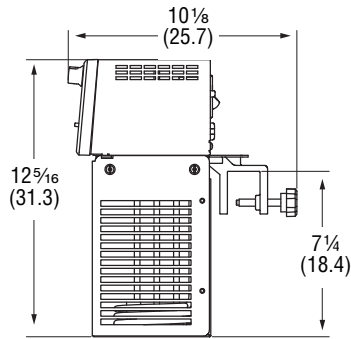

Side View

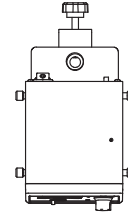

Top View

40861

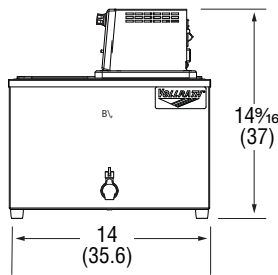

Front View

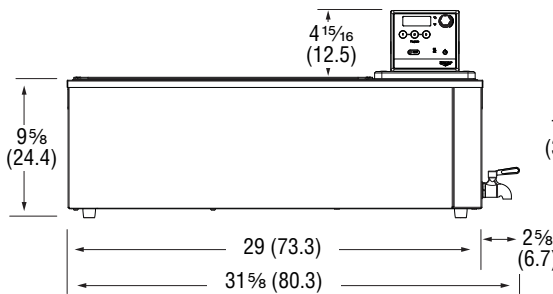

Side View

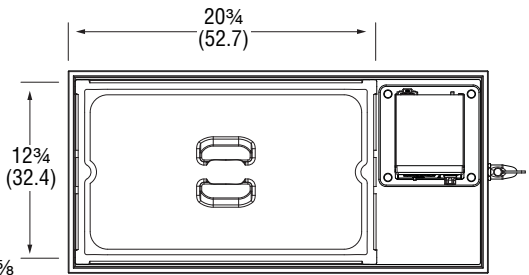

Top View

SPECIFICATIONS

Item No.	Description	Voltage	Watts	Amps	Plug	Shipping Container W x D x H	Weight LB (Kg)
40868	Immersion Circulator (head only)	120V	1100	11	NEMA 5-15P	12 x 8 x 15 1/2 (30.5 x 20.3 x 39.4)	10 1/2 (4.8)
40861	Immersion Circulator (head, bath and cover)				NEMA 5-15P	19 x 34 x 14 1/2 (48.3 x 86.4 x 36.8)	49 (22,2)

Receptacle

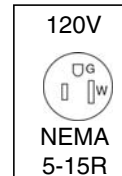

Outperform every day.™

www.vollrath.com

The Vollrath Company, L.L.C.

1236 North 18th Street
 Sheboygan, WI 53081-3201 U.S.A.
 Main Tel: 800.624.2051 or 920.457.4851
 Main Fax: 800.752.5620 or 920.459.6573
 Customer Service: 800.628.0830
 Canada Customer Service: 800.695.8560

Technical Services
techservicereps@vollrathco.com
 Induction Products: 800.825.6036
 Countertop Warming Products: 800.354.1970
 All Other Products: 800.628.0832